

a) configurations favorables : plans simples et compacts à 2 axes de symétrie

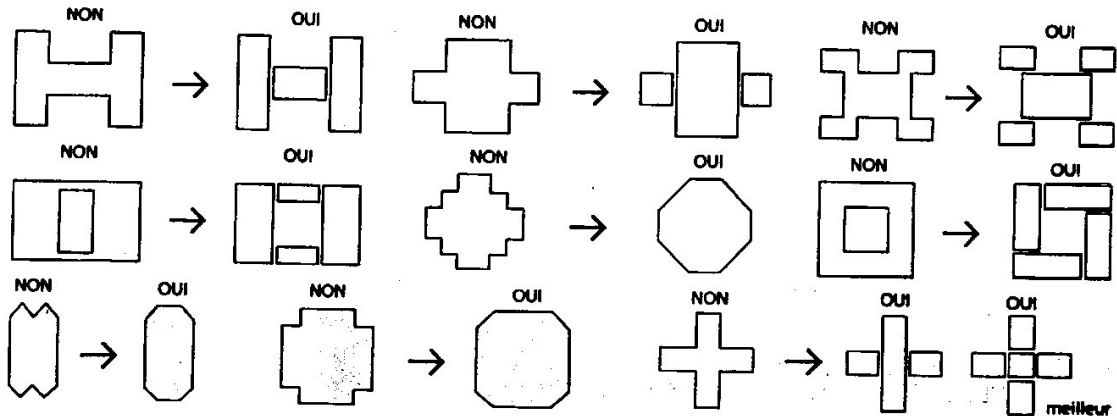

plan complexe à 2 axes de symétrie

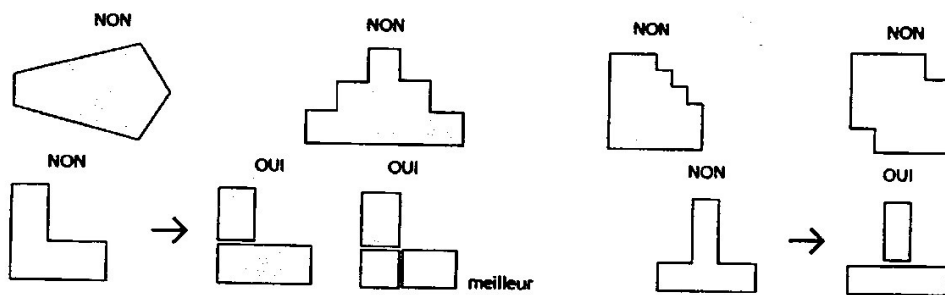

plan à un axe de symétrie

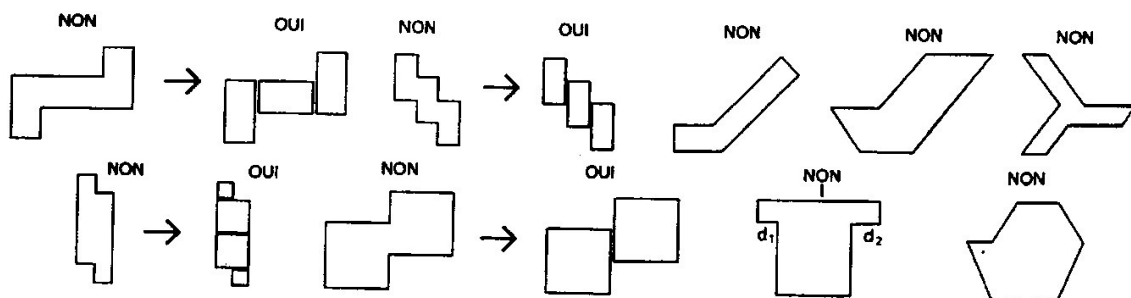

plans sans axes de symétrie

Règles PS 69 / B2 :
tolérable si $d_1 + d_2 \leq 1/4$

b) configurations défavorables et améliorations

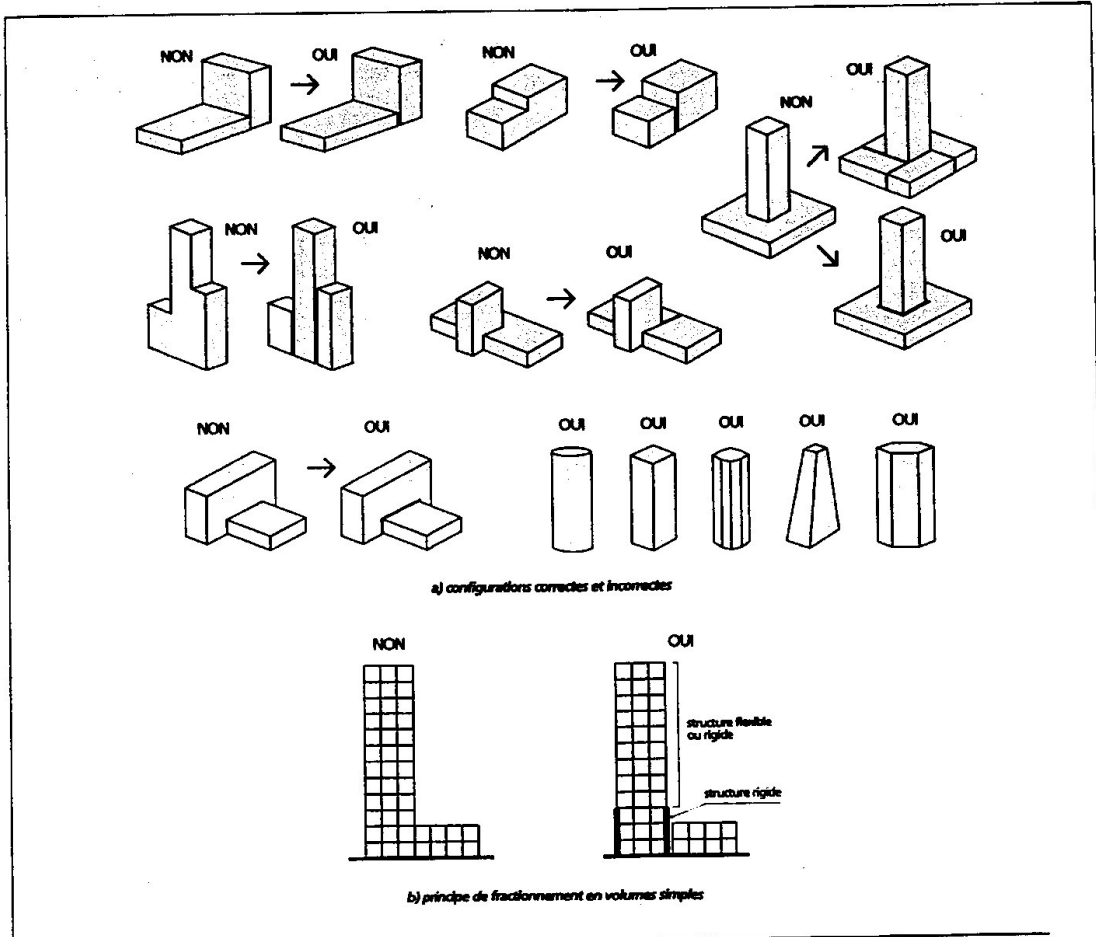
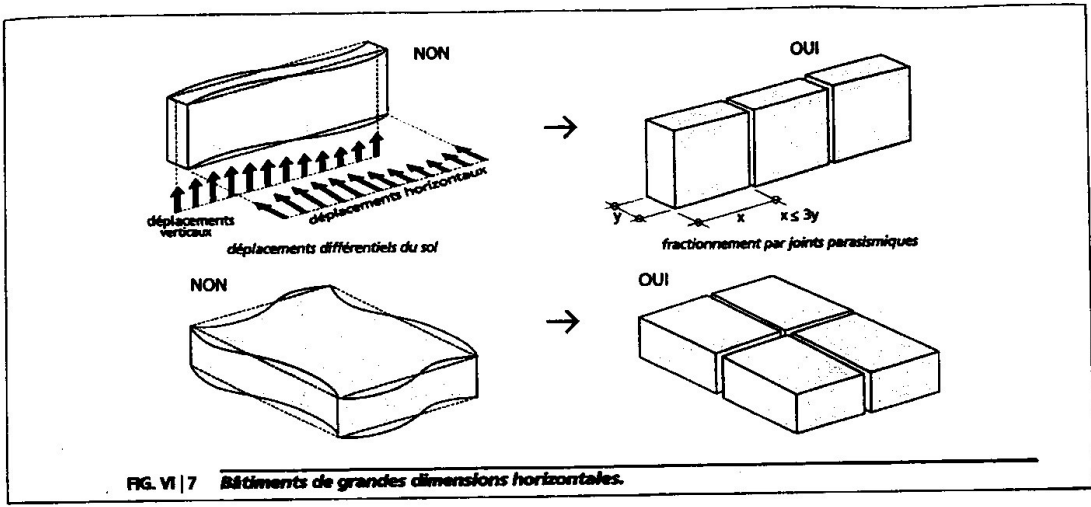

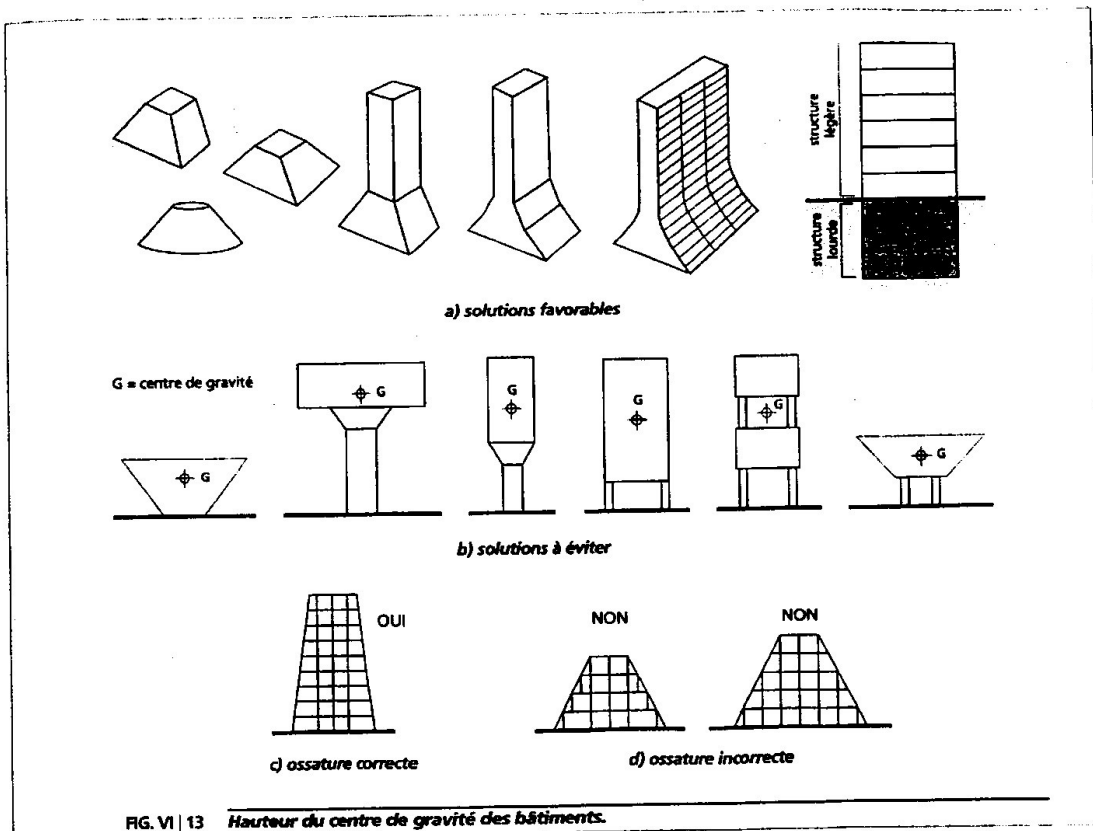
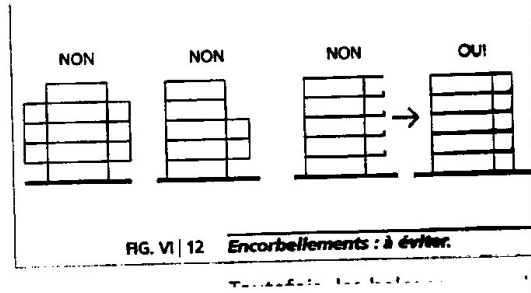
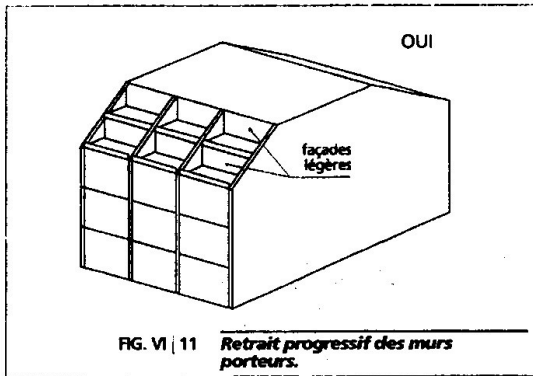
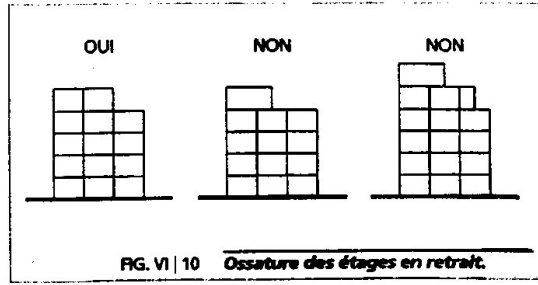
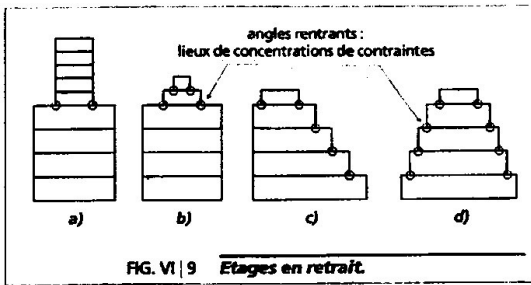

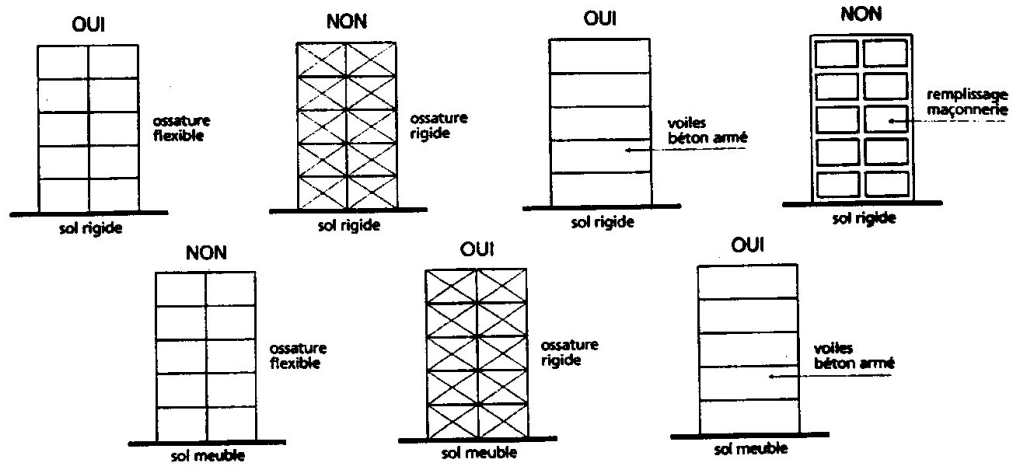

a) prise en compte de la nature du sol

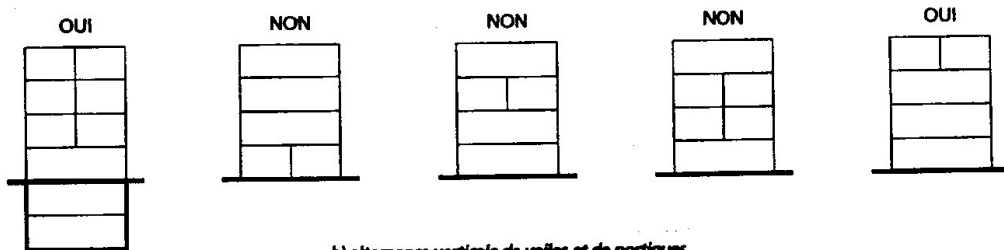

b) alternance verticale de voiles et de portiques

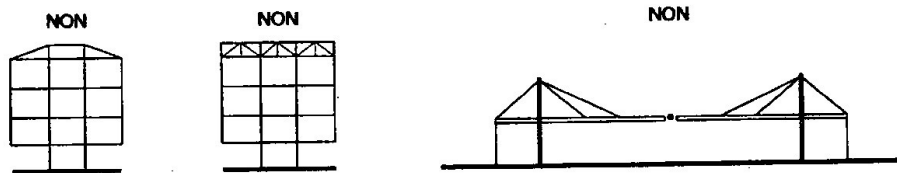

c) structures suspendues : à éviter

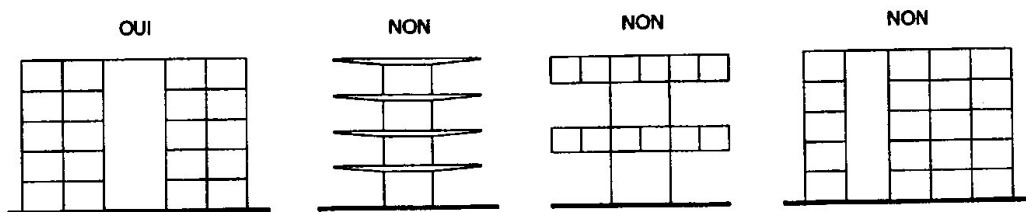

d) bâtiments à noyau central

